

Sink Foster Milano 1013 850

Sinks

Code: 1013 850



DETAILS

Base 60 cm

Edge/Installation Type Undermount

Dimensions 510x500 mm

Standard fittings Fixing hooks, gasket, drain, overflow and siphon, boxed packing

Mixer holes No standard holes

Built-in hole 462x452 mm

Drainer No

Width 51 cm

Material/Finish Foster-brushed finish AISI 304 stainless steel

Bowl dimension 462x400mm

Number of bowls 1 bowl

Waste fitting 3,5" drain

FEATURES

Diamond-shape bottom The draining of water is an important feature in a sink, and it's always taken good care of in Foster products. In the bent-welded sinks, which would have a flat bottom, the proper draining is guaranteed by the elegant beveling, which helps the water flow.

High thickness 1mm thick steel. A significant thickness, which guarantees the maximum sturdiness and durability.

Perimetral overflow The overflow is always a security on the Foster sinks that prevents the overflow of water in case of oversights. The perimeter drain solution improves aesthetics thanks to its square and essential shape.

Save space system Drain and siphon are designed to leave as much space as possible in the under-sink area, more and more useful today for theseparate waste collection systems.

Small radius Bowls with squared shapes with a modern design and an increased capacity, for a minimal aesthetics connected with an extreme practicality.

Space waste fitting The elegant SPACE steel cap closes the drain and leaves no visible residues collected in the basket below. Space also has a small footprint and allows the optimal use of the under-sink compartment.

Triple recess - sliding accessories The Foster Milano sink has an ingenious design that makes it simple to use a large set of optional accessories. On the topmost supporting step, the innovative Black grids slide, creating a large and practical surface to rinse food and crockery. The second step is meant to support and allow the sliding of a complete combination of accessories, which make some operations practical and safe: rinse, drain, slice, grate... everything can be done inside the sink. The third supporting step is on the bottom of the bowl. On this step one can rest the Black grids, making it possible to rinse foodstuffs without their coming in contact with the bottom of the sink, which may be dirty.

TECHNICAL DATA

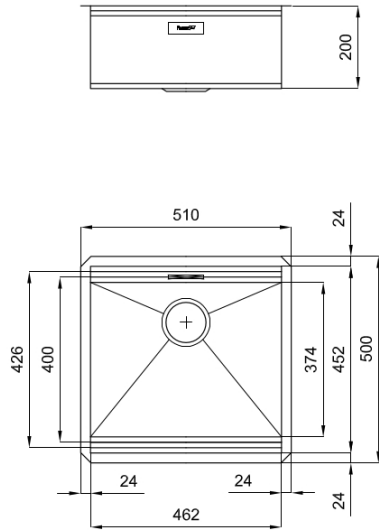

GALLERY



OPTIONAL ACCESSORIES



Black grid 8100 600



Glass chopping board 8631 300



HPDE Twin chopping board 8644 101

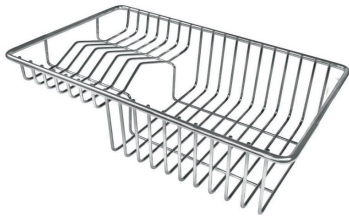

Stainless steel plate rack 8100 303



Walnut-wood chopping board 8642 000



Graters kit with ring-holder and food collection tray 8159 101



Stainless steel perforated tray 8151 000

WARNING:

The accessories 8159101, 8100303,8151000 are only usable in combination with 8644101

OPTIONAL AUTOMATIC WASTE FITTINGS



Automatic waste fitting 8407 113



Space automatic waste fitting 8407 108



Space automatic waste fitting 8407 109



Space Light automatic waste fitting 8407 117



Space Milano automatic waste fitting 8407 115



Space Push automatic waste fitting 8407 116